

I NUMERI FINO A 20

1 UNISCI I PUNTINI DA 14 A 20 PER COMPLETARE LA SEDIA.

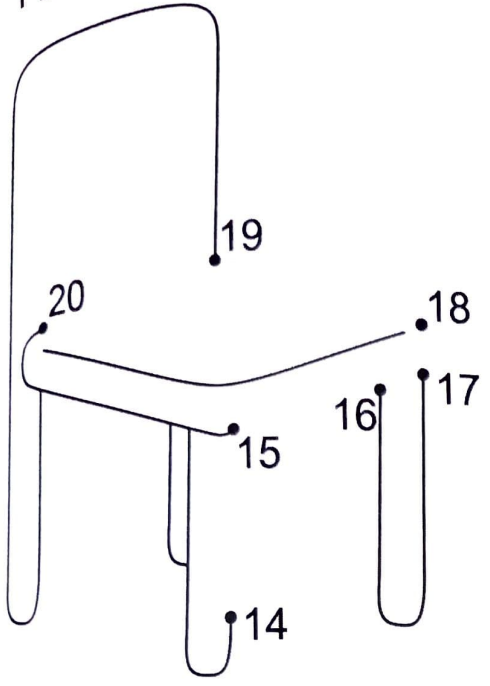

2 UNISCI I PUNTINI DA 20 A 9 PER COMPLETARE IL CANE.

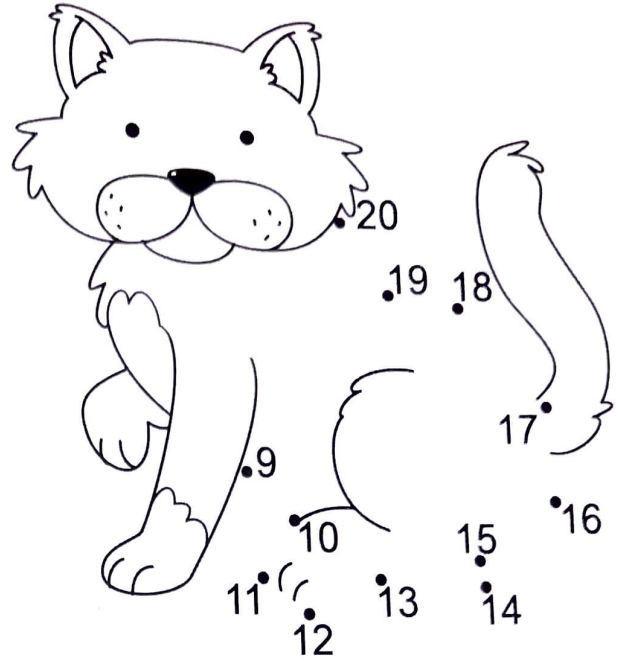

3 IN OGNI FIORE COLORA DI AZZURRO I NUMERI **MINORI** E DI GIALLO I NUMERI **MAGGIORI** DEL NUMERO AL CENTRO.

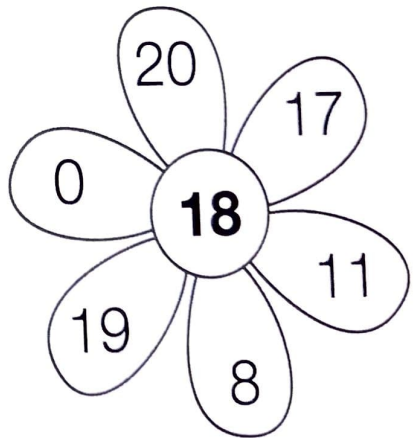
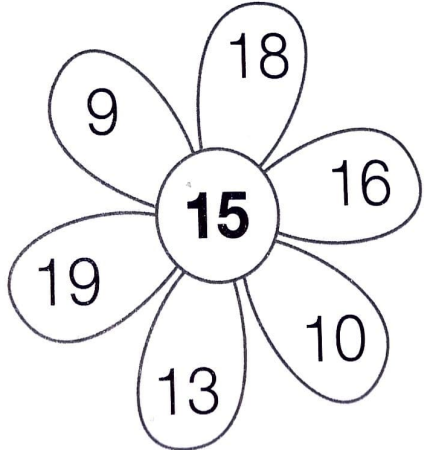
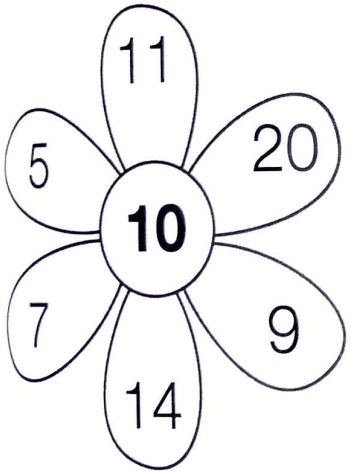

4 SCRIVI IL NUMERO PRECEDENTE.

..... 12 18
 20 16

5 SCRIVI IL NUMERO SUCCESSIVO.

13 19
 10 16

DA 0 A 20 E DA 20 A 0

1 RISCRIVI I SEGUENTI NUMERI SULLA LINEA.

11 **20** **7** **13** **10** **17** **16**

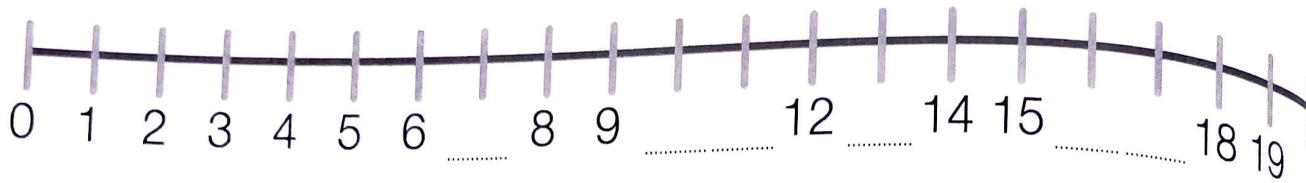

2 COMPLETA IL BRUCO CON I NUMERI DA 0 A 20.

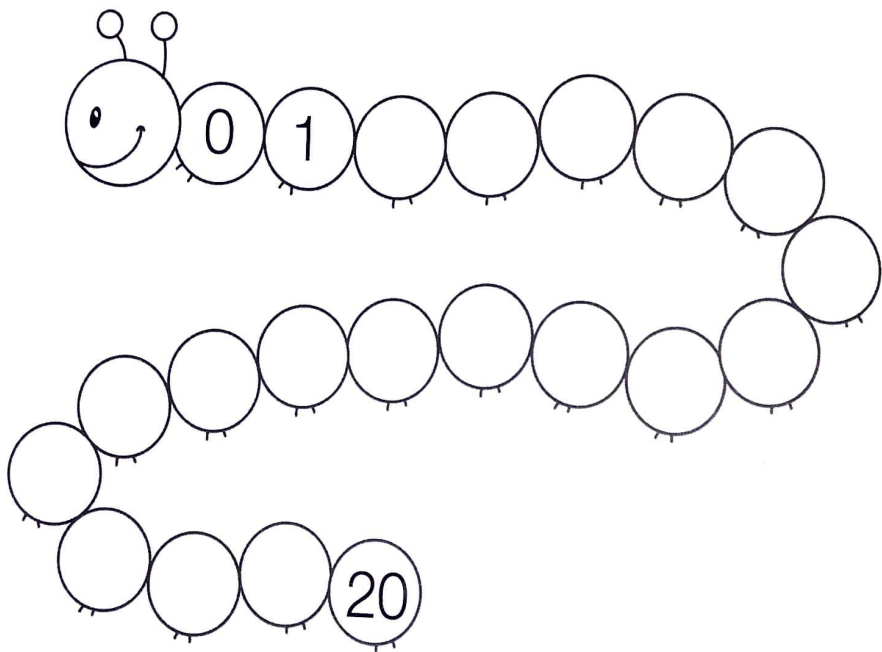

3 COMPLETA LE CASE CON I NUMERI DA 20 A 0.

